

KENDU CREATOR MASK



A big **THANK YOU**
for downloading the Kendu Creator Mask.

With some everyday stationaries and several hours of your time, even without paper-crafting experience, you will be able to make the mask on your own. So enjoy the process and let's get to *work*.

To craft this mask, you will need:

1. Printer

A standard office printer for A4 paper.

2. Thick paper/Cardstock Paper

Paper thickness should be around 200-250gsm (70-90lbs paper). Keep in mind that choosing thicker paper can make it harder for you to craft the mask. Use colored cardstock, or color using spray paint/acrylic paint.

3. Ruler

Plastic/metal ruler (metal is preferable)

4. Glue

Prepare both craft glue (white wood glue/PVA) and glue stick.

5. Scissors or cutter/X-Acto knife

It is best to use both. Scissors are faster and more useful in some cases, but a few parts are hard to reach with scissors, so having a cutter knife will also come in handy.

6. Something like blunt knife/empty pen

For engraving/marketing/scoring the folding lines, but without cutting through the paper.

STEPS

1. Print

Print the templates. If your printer can handle printing on thicc paper, then after printing, please skip step 2-3 and go straight to step 4.

Make sure to set the print size to 100% or 1:1 to preserve the actual size.

Do not choose "scale to fit" or other similar settings.

The printed template lines will be the INSIDE of the mask, so no lines/numbers printed will be visible from the outside.

2. Cut

Roughly cut out all of the parts using scissors. No precise cutting is needed in this step.

3. Gluing parts onto the cardstock

Use the glue stick to stick the parts on step 2 to your thick paper.

4. Scoring folding lines

To make folding easier, it is best to score all of the folding lines. Take a ruler and score each folding line with your scoring tool of choice.

5. Cut it all out

Cut all the parts along the full line (———).

Do not cut along the dashed lines. Some parts might be difficult to reach with scissors, so use a cutter knife if necessary.

6. Folding

Dash lines - - - - - represent mountain folds.

Dot-Dash lines -•-•-•-•- represent valley folds.

Please make sure to fold accordingly.

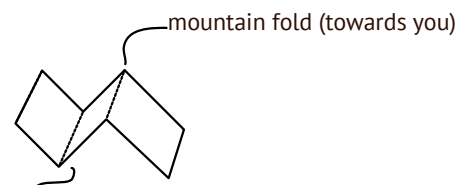

valley fold (away from you)

7. Gluing parts together

Before gluing, if you print on a colorless cardstock, then use spray paint or acrylic paint to color the outer side of the parts (the side with no lines and numbers).

Each part has numbers on it, and every number has a match. Look for the corresponding numbers and stick them to each other using the craft glue. When sticking parts together, make sure the flap is going to be on the INSIDE of the mask. (remember, the side with the lines and numbers is the inside of the mask)

HEADBAND

Make a headband so that you can wear the mask tightly onto your head.

Using your cardstock, cut out the shape below. Please note that the image below is just for reference and does not display its actual measurement.

Cut part (A), piece them together so that it creates a ring that fits your head.

Stick part (A) and (B) together with glue/tape/staple.

Stick the piece together to the inside of the mask.

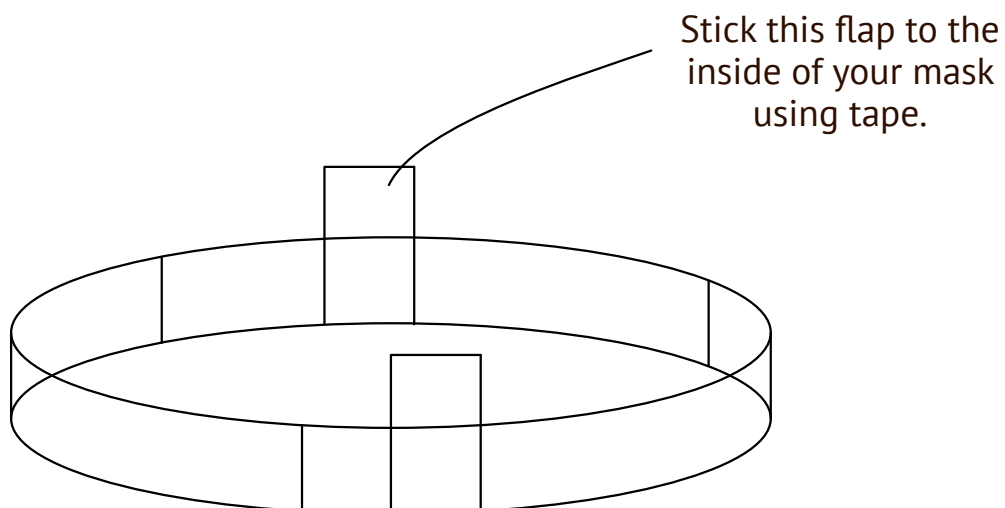
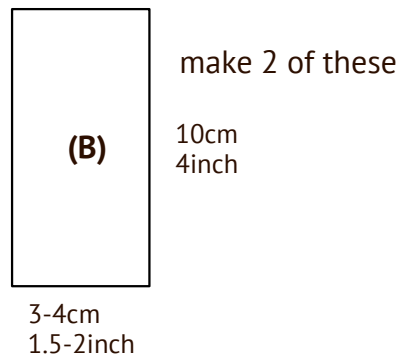
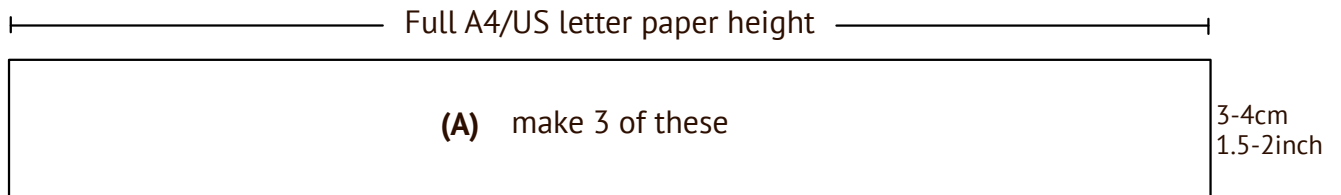

(O) ORANGE

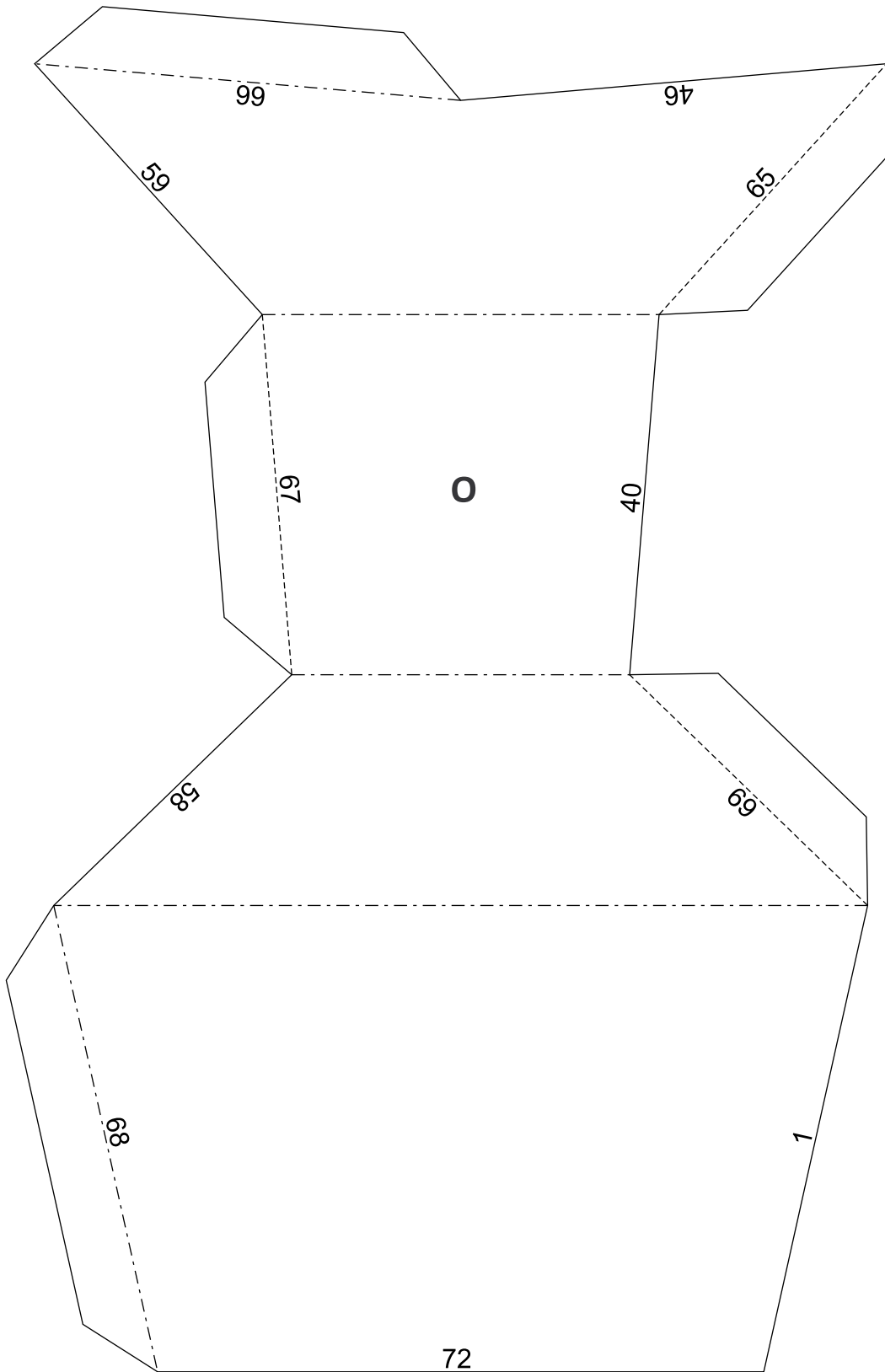

(O) ORANGE

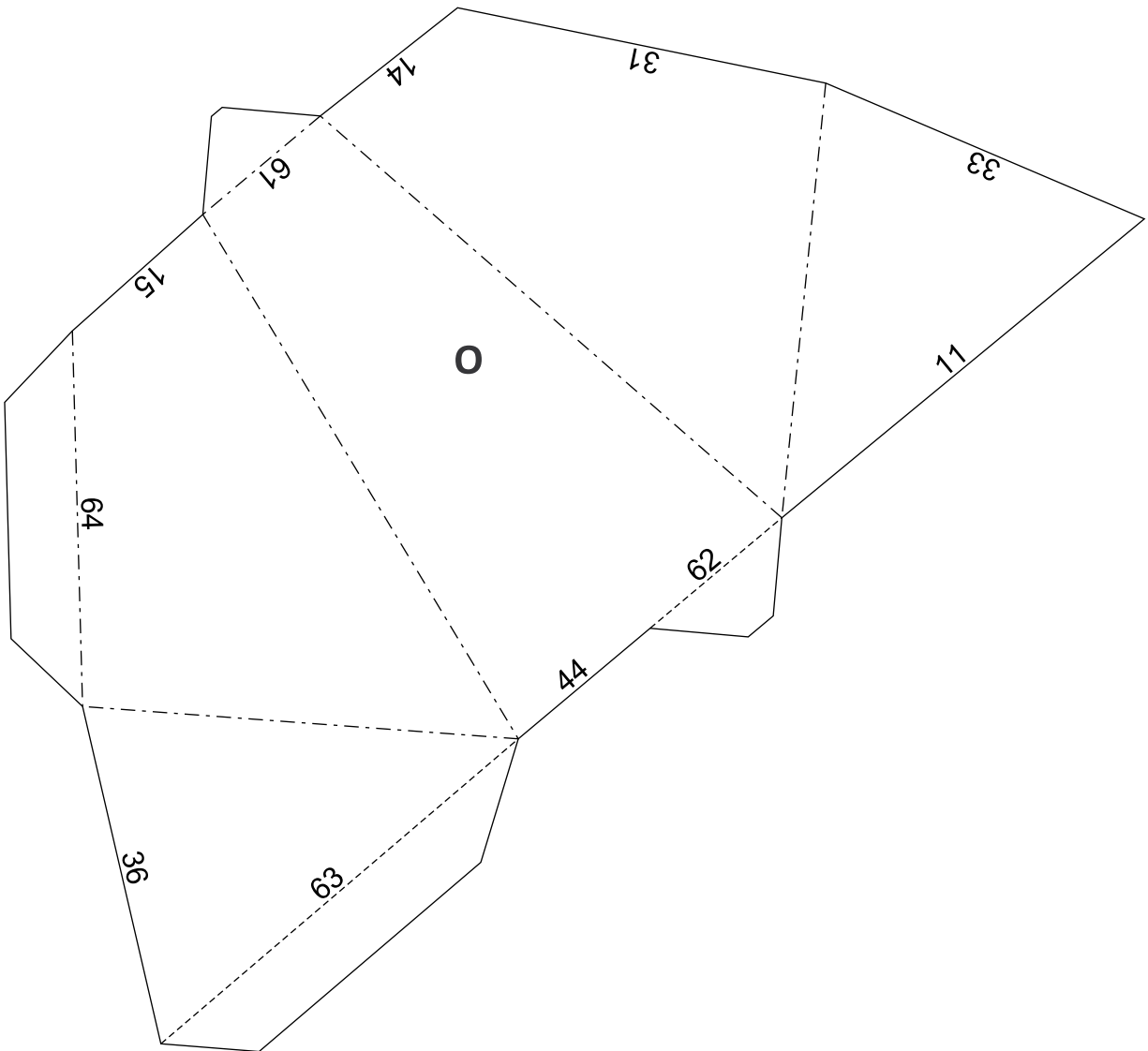
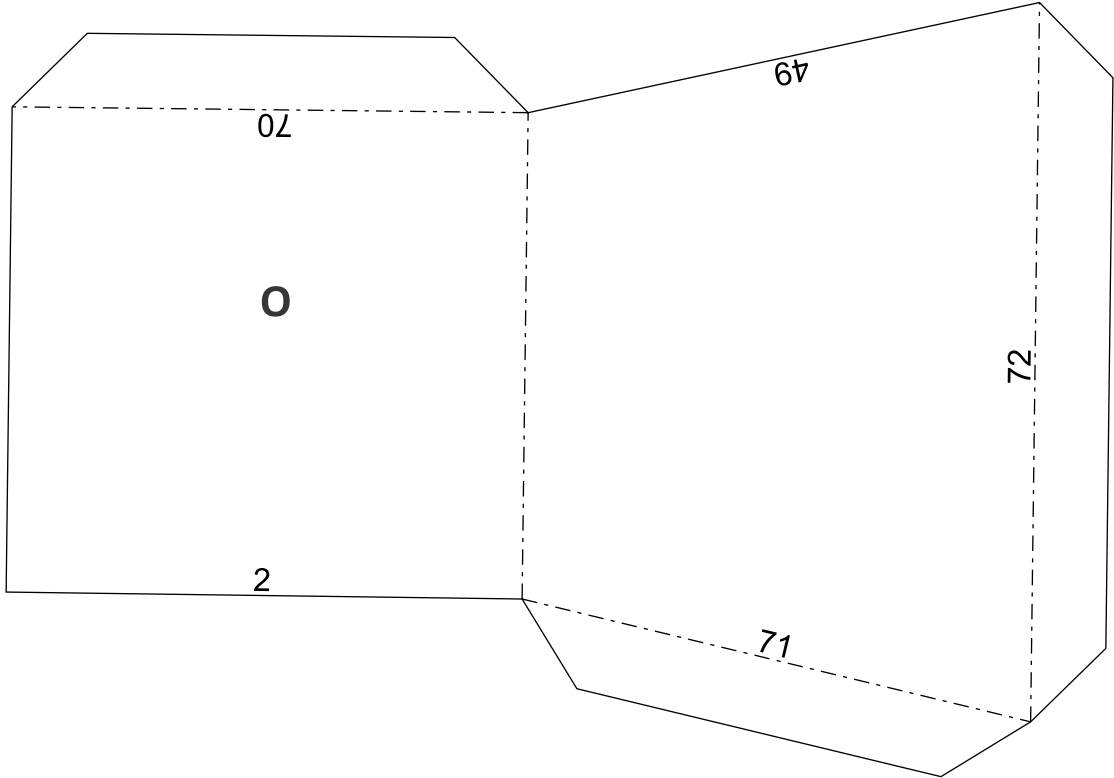

(O) ORANGE

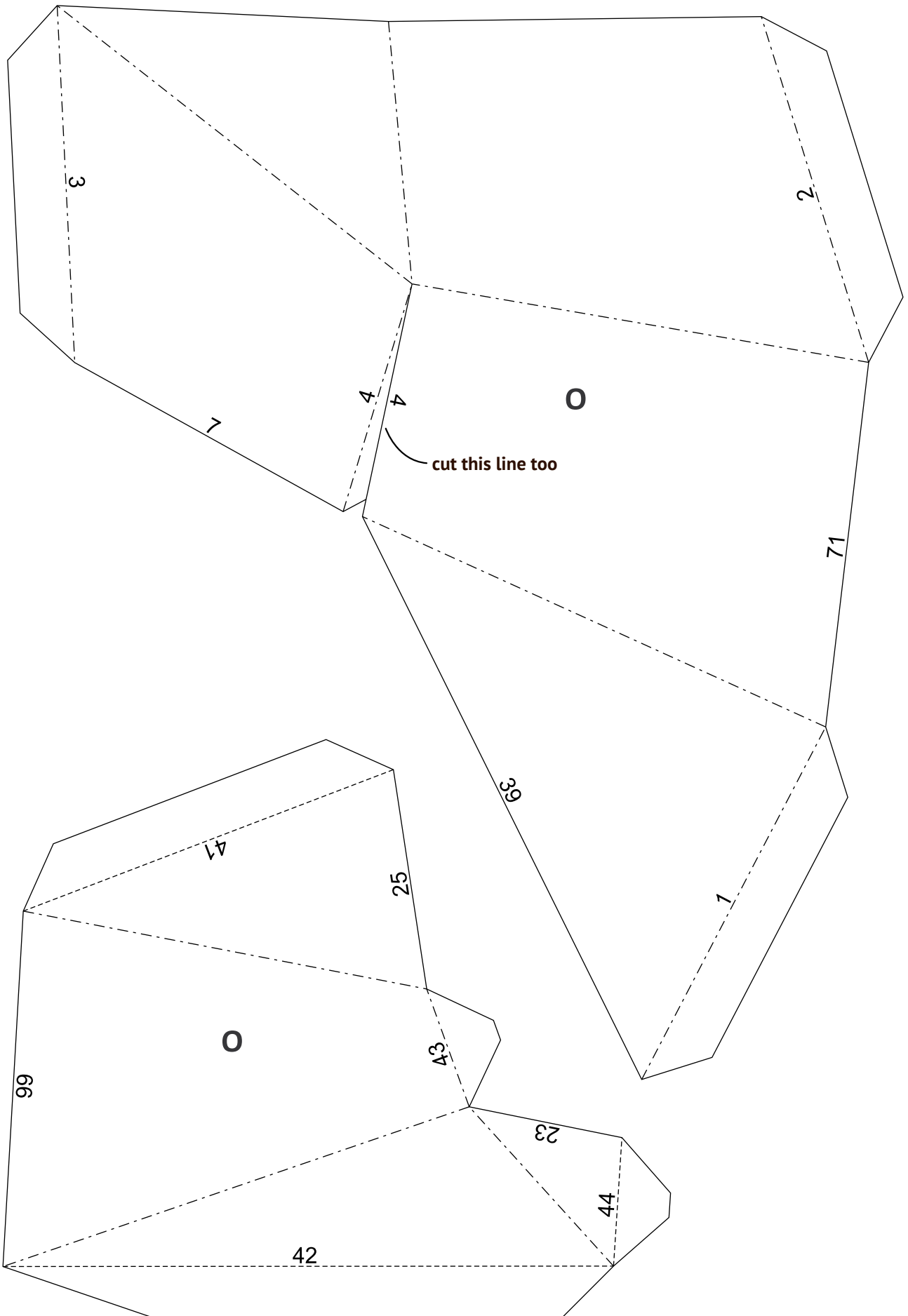

(O) ORANGE

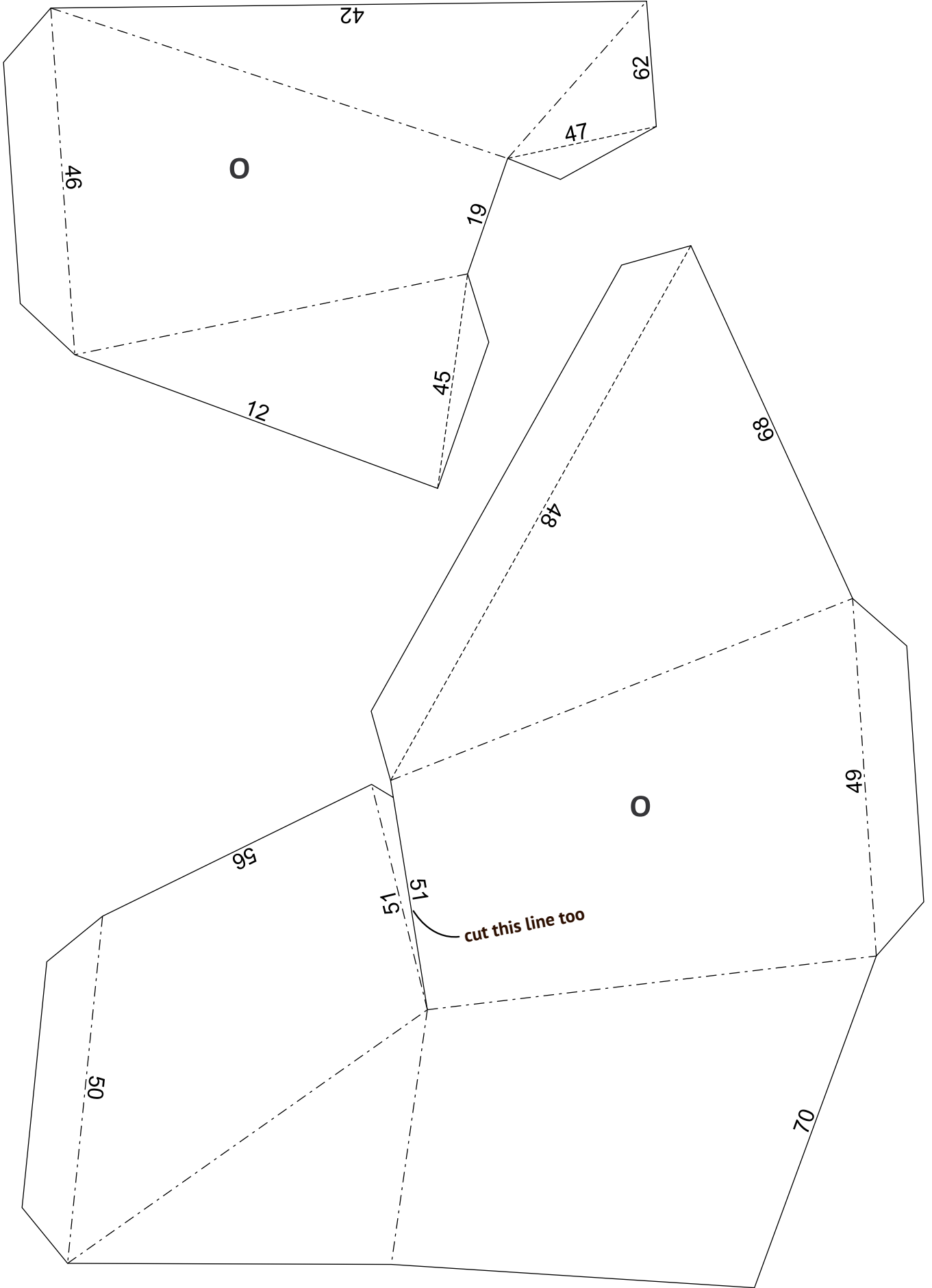

(O) ORANGE

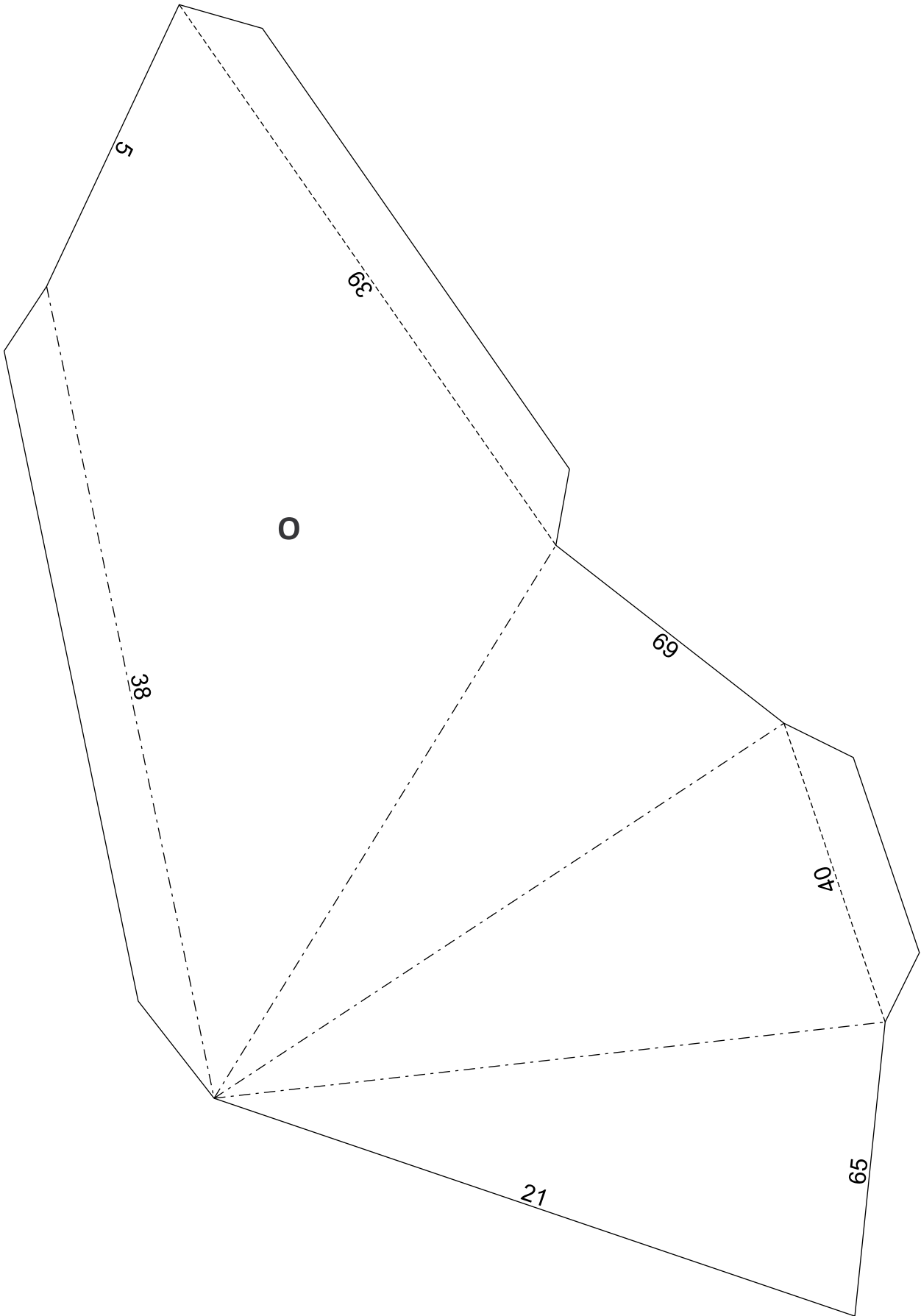

(O) ORANGE

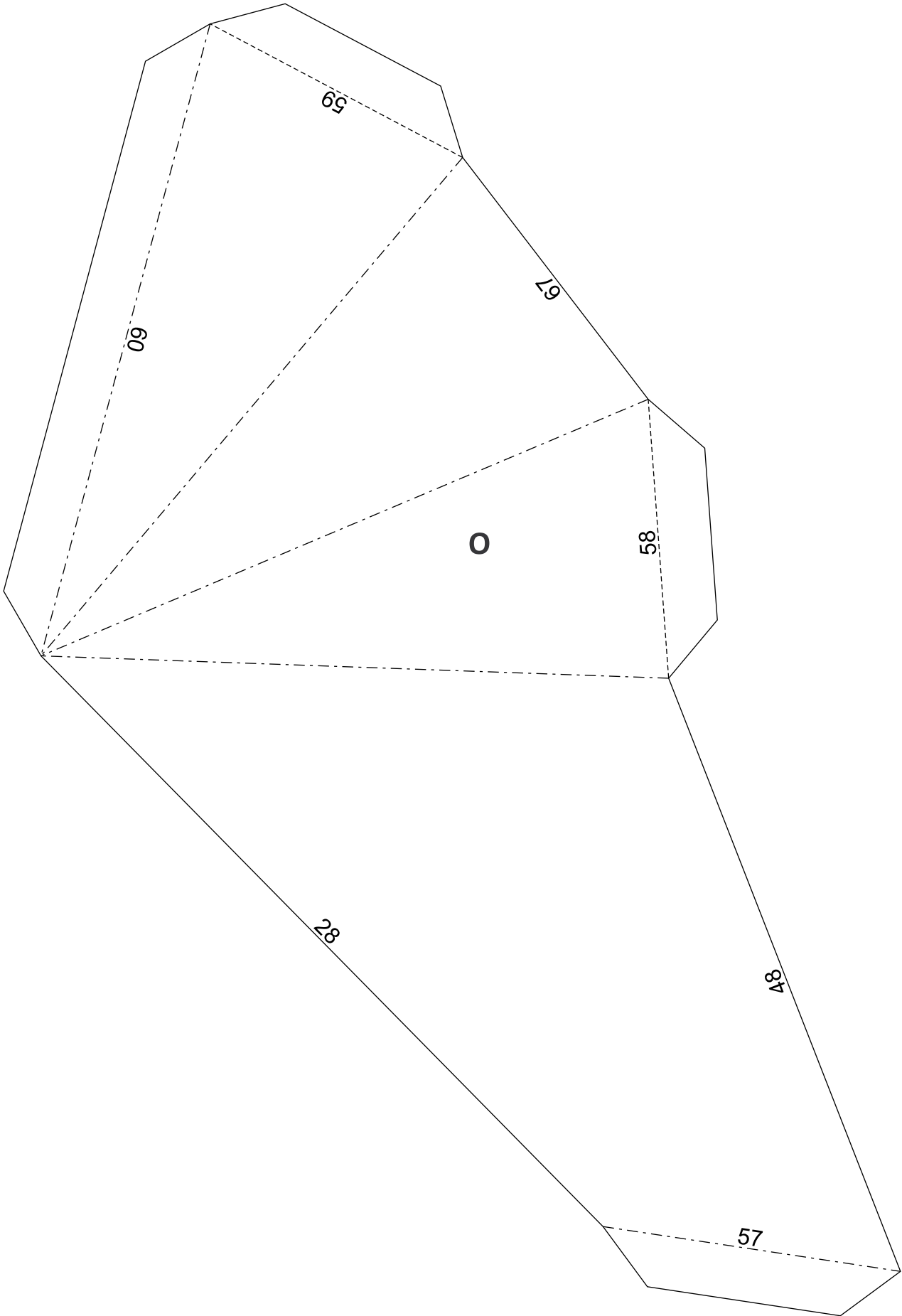

(O) ORANGE

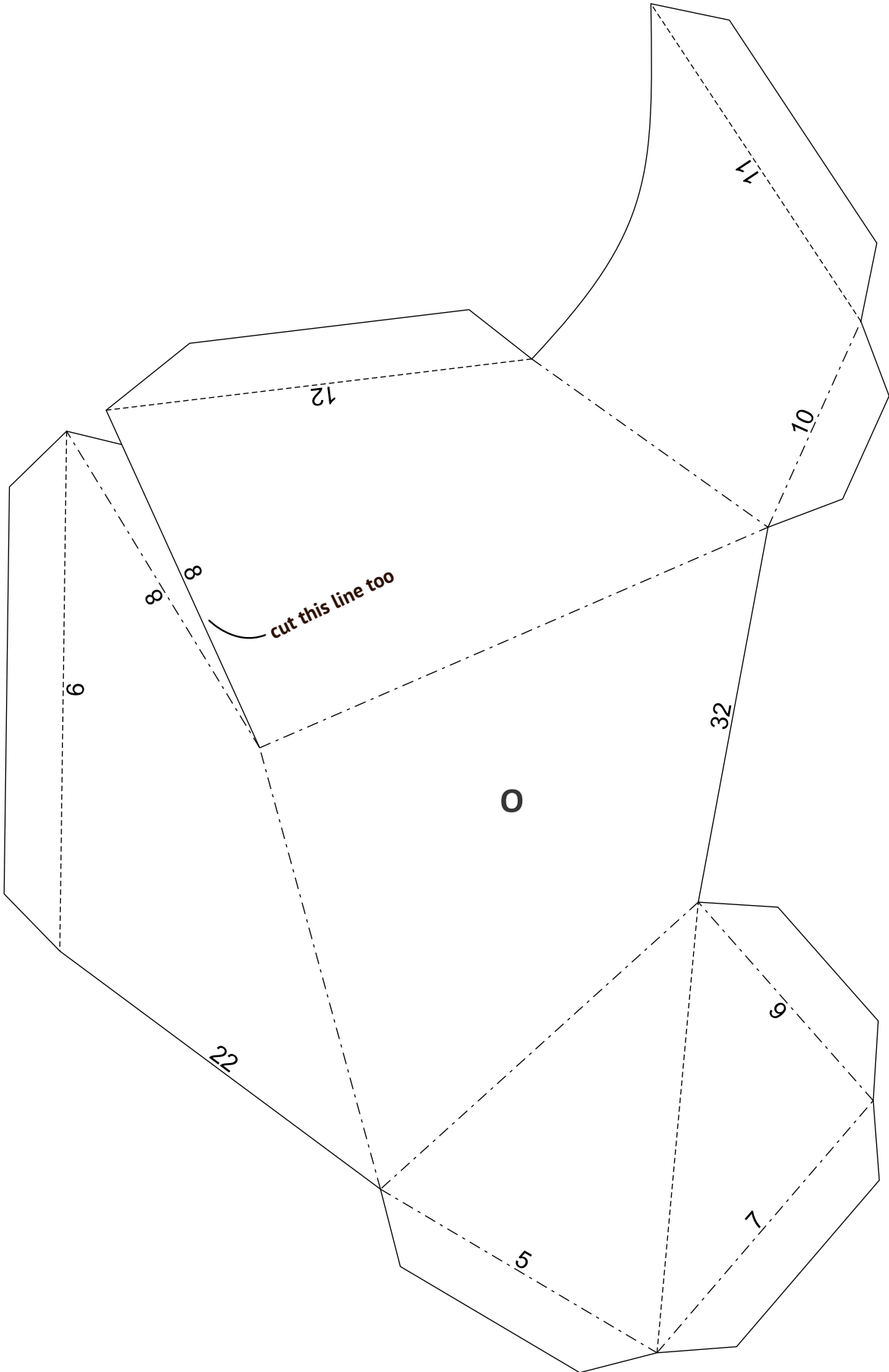

(O) ORANGE

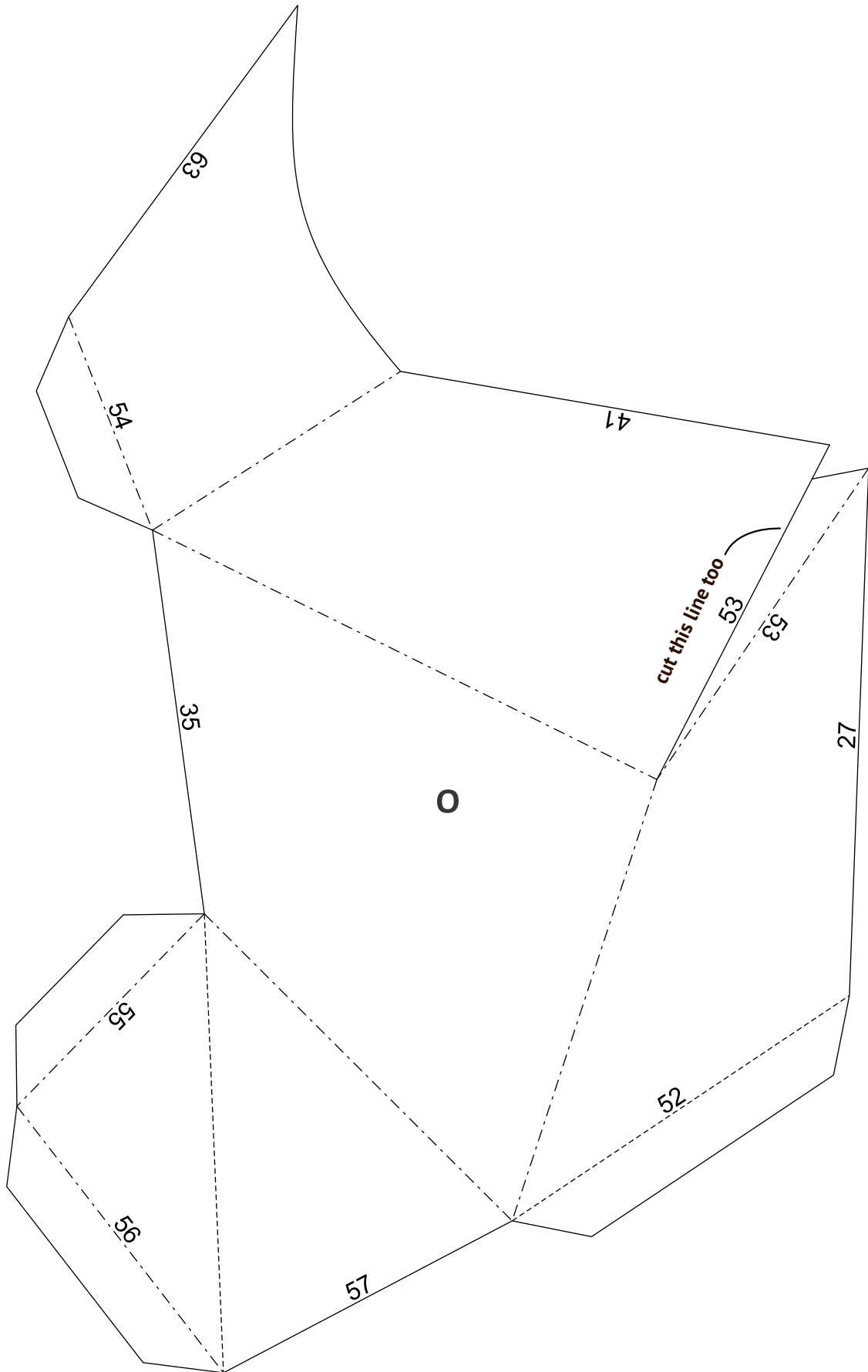

(W) WHITE

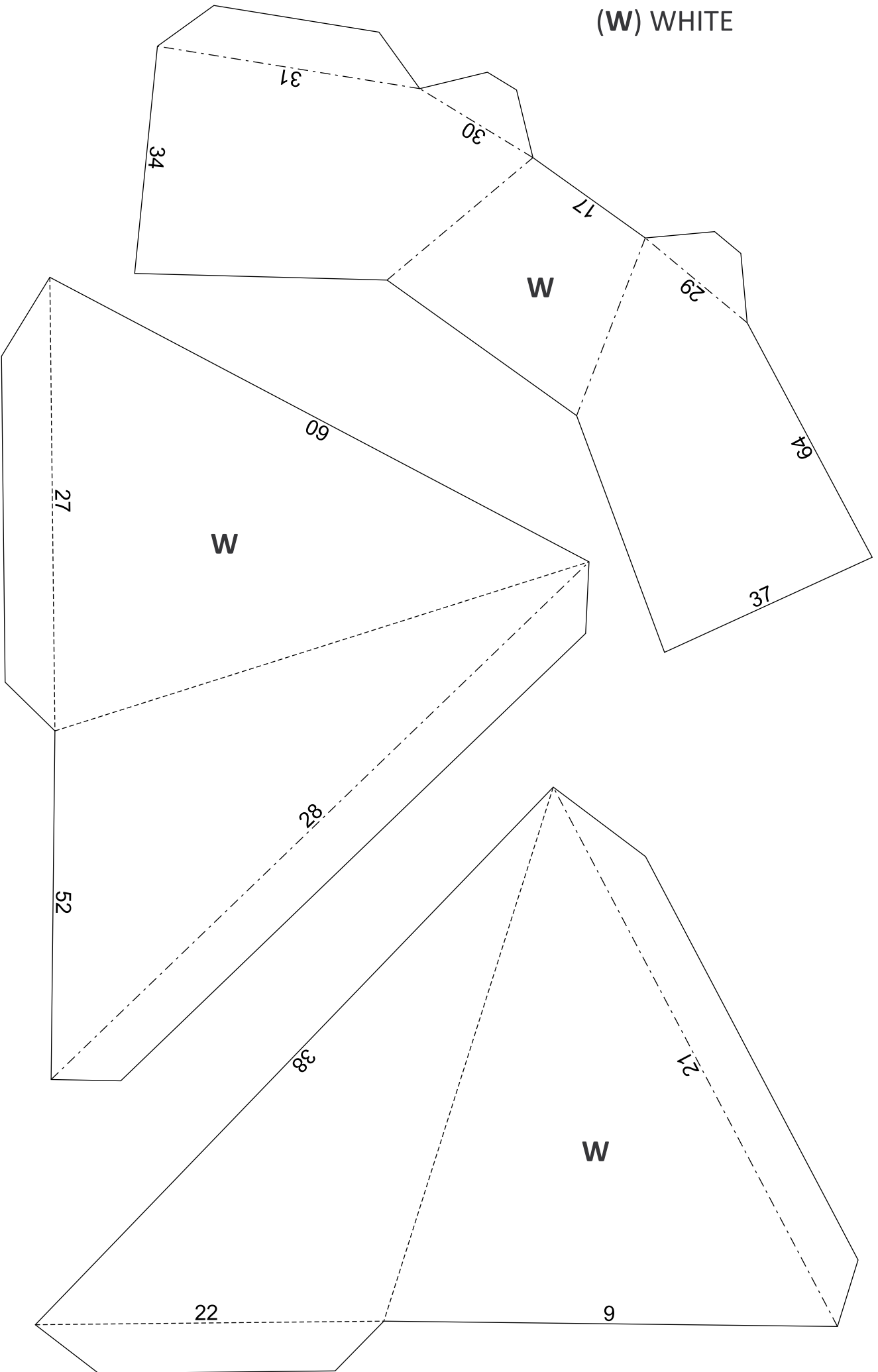

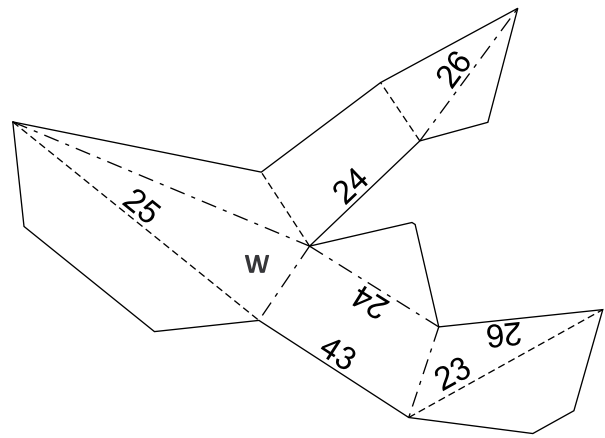
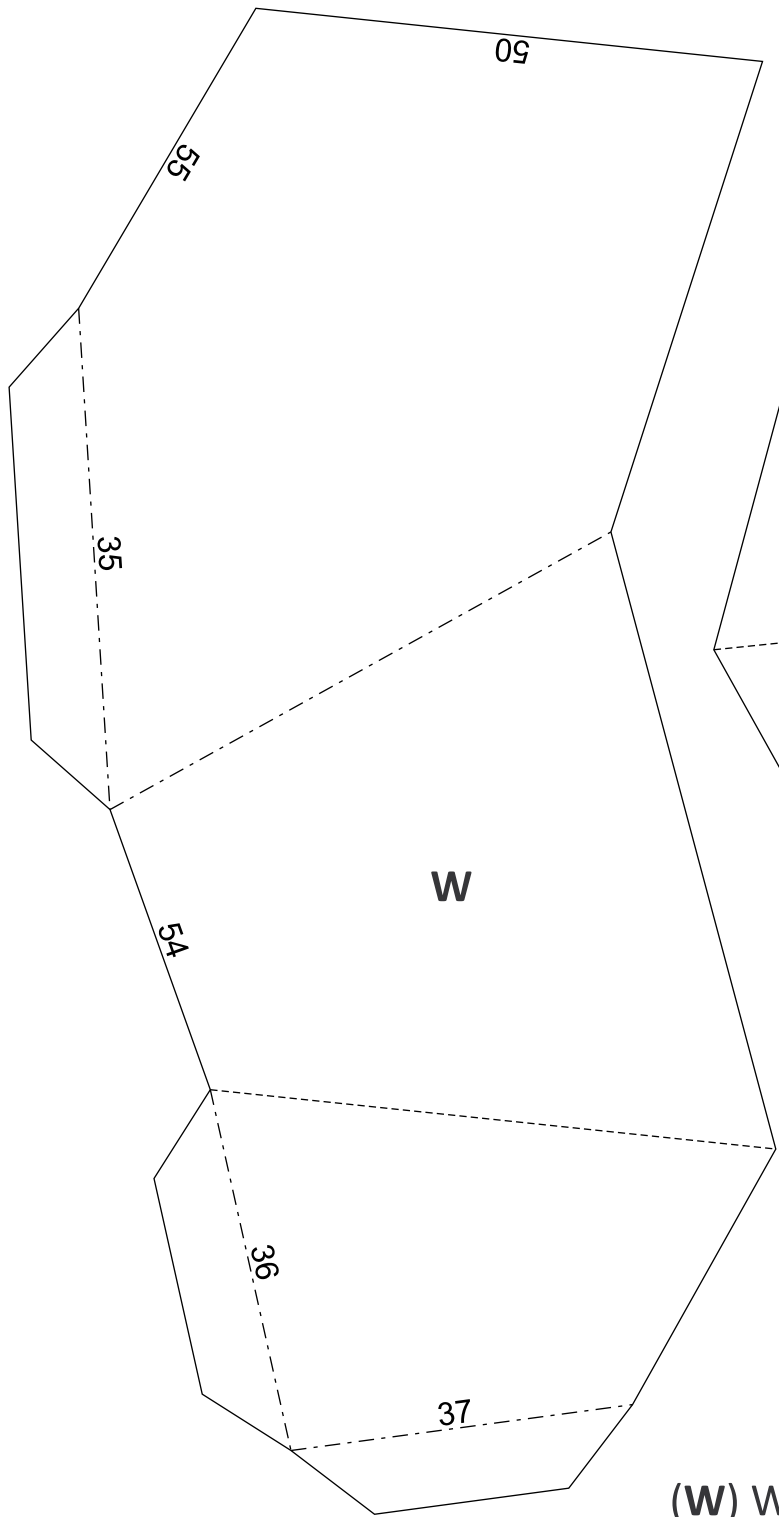
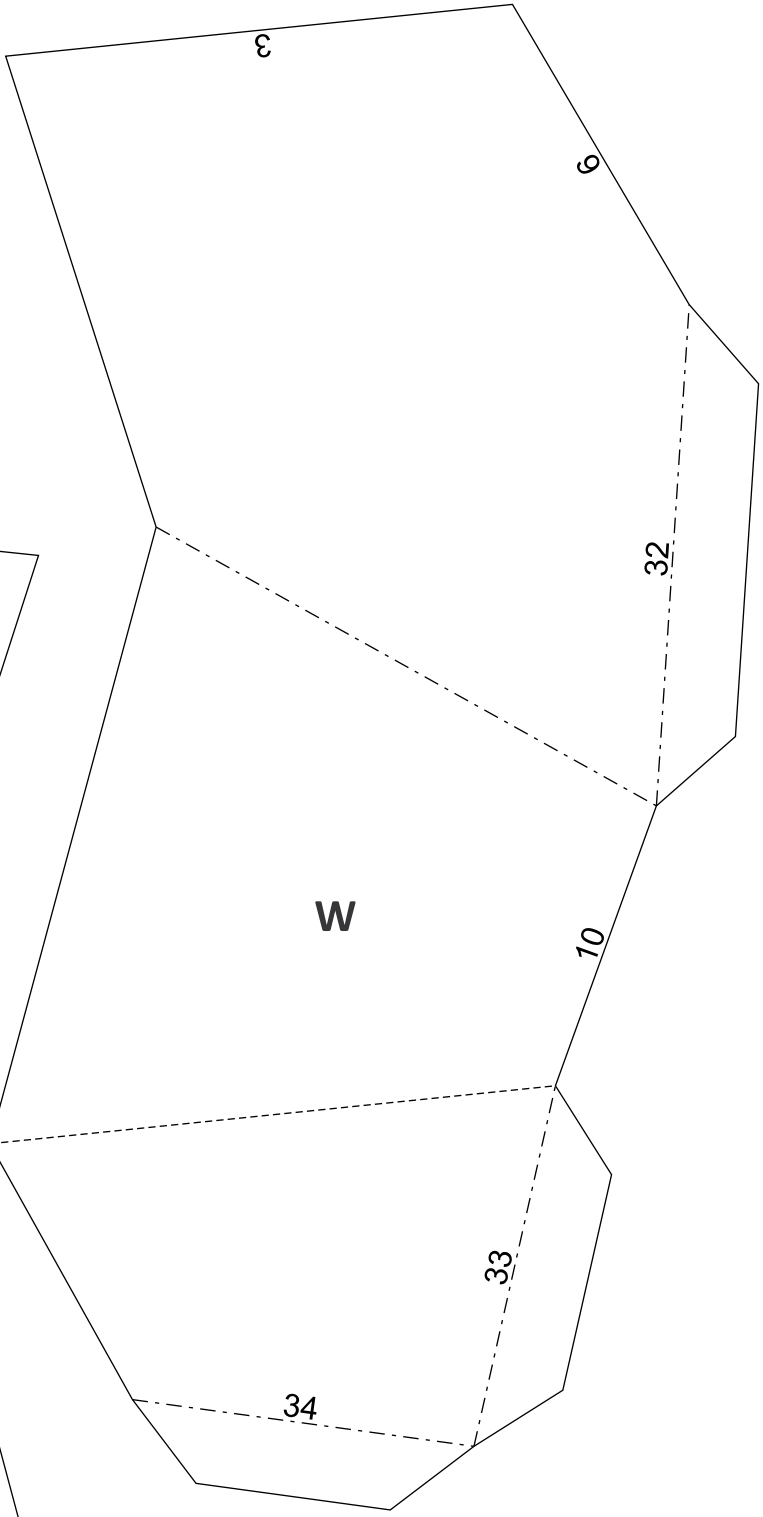
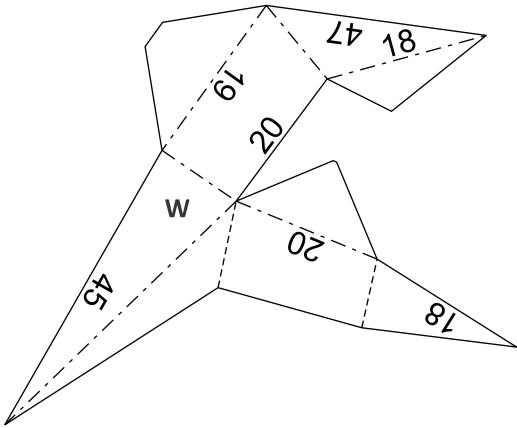

(W) WHITE

(B) BLACK

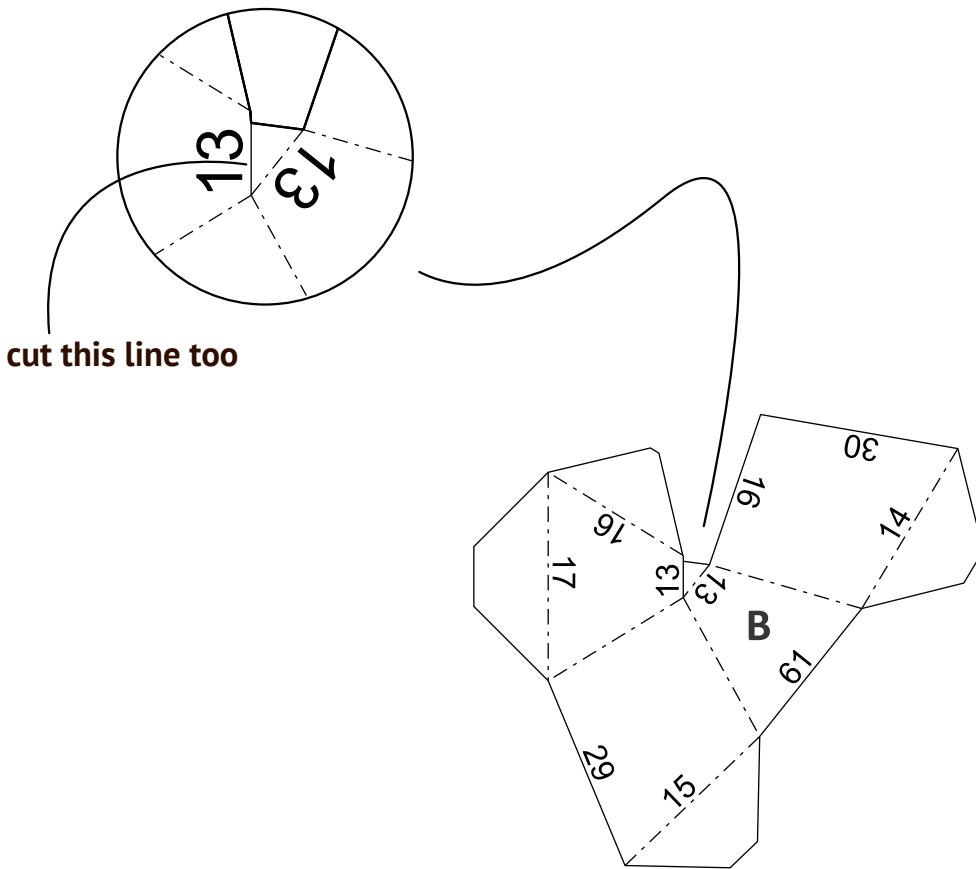



Enjoy your mask!